



VVF53..  
VVF53..K



VXF53..

ACVATIX™

## 2- and 3-port valves with flanged connections, PN 25

VVF53..  
VXF53..

From the large-stroke valve line

- High-performance valves for medium temperatures from -20...220 °C
- Valve body of nodular cast iron EN-GJS-400-18-LT or higher
- DN 15...250
- $k_{vs}$  0.16...630 m<sup>3</sup>/h
- Flange type 21, flange design B
- VVF53..K with pressure compensation to handle high differential pressure
- Equipable with electro-motoric actuators SAX.., SAV.. or electro-hydraulic actuators SKD.., SKB.., SKC..

### Use

In boiler, district heating and refrigeration plants, cooling towers, heating groups, and in air handling units as control or shutoff valves.

For use in closed or open hydraulic circuits (observe cavitation).

## Type summary

	Valves	Actuators				SAX.. <sup>3)</sup>		SKD.. <sup>2)</sup>		SKB..		SAV <sup>3)</sup>		SKC..	
		Stroke				20 mm		20 mm		40 mm		40 mm			
		Positioning force				800 N		1000 N		2800 N		1600 N		2800 N	
	PN 25 PN 16 <sup>1)</sup>	Data sheet				N4501		N4561		N4664		N4503		N4566	
		Stock no.	DN	k <sub>vs</sub> [m <sup>3</sup> /h]	S <sub>v</sub>	Δp <sub>s</sub>	Δp <sub>max</sub>	Δp <sub>s</sub>	Δp <sub>max</sub>	Δp <sub>s</sub>	Δp <sub>max</sub>	Δp <sub>s</sub>	Δp <sub>max</sub>	Δp <sub>s</sub>	Δp <sub>max</sub>
						[kPa]									
<b>Fluids</b> Preferred flow direction A-AB with fluids for low noise operation and high kvs-values with all actuator types	VVF53.15-0.16	S55208-V100	15	0.16	> 50	2500	1200	2500	1200	2500	1200	-	-	-	-
	VVF53.15-0.2	S55208-V101	15	0.2											
	VVF53.15-0.25	S55208-V102	15	0.25											
	VVF53.15-0.32	S55208-V103	15	0.32											
	VVF53.15-0.4	S55208-V104	15	0.4											
	VVF53.15-0.5	S55208-V105	15	0.5											
	VVF53.15-0.63	S55208-V106	15	0.63											
	VVF53.15-0.8	S55208-V107	15	0.8											
	VVF53.15-1	S55208-V108	15	1											
	VVF53.15-1.25	S55208-V109	15	1.25											
	VVF53.15-1.6	S55208-V110	15	1.6											
	VVF53.15-2	S55208-V111	15	2											
	VVF53.15-2.5	S55208-V112	15	2.5											
	VVF53.15-3.2	S55208-V113	15	3.2											
	VVF53.15-4	S55208-V114	15	4											
	VVF53.20-6.3	S55208-V116	20	6.3											
	VVF53.25-5	S55208-V117	25	5											
	VVF53.25-6.3	S55208-V118	25	6.3											
	VVF53.25-8	S55208-V119	25	8											
	VVF53.25-10	S55208-V120	25	10											
	VVF53.32-16	S55208-V122	32	16											
	VVF53.40-12.5	S55208-V123	40	12.5											
	VVF53.40-16	S55208-V124	40	16											
VVF53.40-20	S55208-V125	40	20												
VVF53.40-25	S55208-V126	40	25												
VVF53.50-31.5	S55208-V127	50	31.5												
VVF53.50-40	S55208-V128	50	40												
VVF53.65-63	S55208-V129	65	63	> 50	-	-	-	-	-	-	-	-	-	-	
VVF53.80-100	S55208-V130	80	100												
VVF53.100-160	S55208-V131	100	160												
VVF53.125-250	S55208-V132	125	250												
VVF53.150-400	S55208-V133	150	400												
VVF53.50-40K	S55208-V134	50	40												
VVF53.65-63K	S55208-V135	65	63												
VVF53.80-100K	S55208-V136	80	100	> 100	-	-	-	-	-	-	-	-	-	-	
VVF53.100-150K	S55208-V158	100	150												
VVF53.125-220K	S55208-V159	125	220												
VVF53.150-315K	S55208-V160	150	315	> 50	-	-	-	-	-	-	-	-	-	-	
VVF53.200-450K	S55208-V161	200	450												
VVF53.250-630K	S55208-V162	250	630												

<sup>1)</sup> DN 15...50: Flange dimensions for PN 16 and PN 25

DN 65...250: Flange dimensions only for PN 25

<sup>2)</sup> Usable up to a max. medium temperature of 150 °C

<sup>3)</sup> Usable up to a max. medium temperature of 130 °C









DN = Nominal size

k<sub>vs</sub> = Flow nominal value of cold water (5...30 °C) through the fully opened valve (H<sub>100</sub>) at a differential pressure of 100 kPa (1 bar)

S<sub>v</sub> = Rangeability

Δp<sub>s</sub> = Maximum permissible differential pressure at which the motorized valve still closes securely against the pressure

Δp<sub>max</sub> = Maximum permissible differential pressure across the valve's throughport for the entire positioning range of the motorized valve

Valves	Actuators				SAX.. <sup>5)</sup>	SKD.. <sup>2)</sup>	SKB..	SAV.. <sup>5)</sup>	SKC..				
	Stroke				20 mm				40 mm				
	Positioning force				800 N	1000 N	2800 N	1600 N	2800 N				
PN 25 PN 16 <sup>1)</sup>	Data sheet				N4501	N4561	N4664	N4503	N4566				
	Stock no.	DN	k <sub>vs</sub> [m <sup>3</sup> /h]	S <sub>v</sub>	Δp <sub>s</sub>	Δp <sub>max</sub>	Δp <sub>s</sub>	Δp <sub>max</sub>	Δp <sub>s</sub>	Δp <sub>max</sub>	Δp <sub>s</sub>	Δp <sub>max</sub>	
					[kPa]								
<b>Steam</b> <sup>3)</sup> Exclusive flow direction AB-A for steam. Also useful for maximum close-off pressure Δp <sub>s</sub> and maximum differential pressure in operation (Δp <sub>max</sub> ) with fluids. Use with electro-hydraulic actuators only	VVF53.15-0.16	S55208-V100	15	0.16									
	VVF53.15-0.2	S55208-V101	15	0.2									
	VVF53.15-0.25	S55208-V102	15	0.25									
	VVF53.15-0.32	S55208-V103	15	0.32									
	VVF53.15-0.4	S55208-V104	15	0.4									
	VVF53.15-0.5	S55208-V105	15	0.5									
	VVF53.15-0.63	S55208-V106	15	0.63									
	VVF53.15-0.8	S55208-V107	15	0.8									
	VVF53.15-1	S55208-V108	15	1									
	VVF53.15-1.25	S55208-V109	15	1.25									
	VVF53.15-1.6	S55208-V110	15	1.6									
	VVF53.15-2	S55208-V111	15	2									
	VVF53.15-2.5	S55208-V112	15	2.5									
	VVF53.15-3.2	S55208-V113	15	3.2									
	VVF53.15-4 <sup>4)</sup>	S55208-V114	15	3.6									
	VVF53.20-6.3 <sup>4)</sup>	S55208-V116	20	5									
	VVF53.25-5	S55208-V117	25	5									
	VVF53.25-6.3	S55208-V118	25	6.3									
	VVF53.25-8	S55208-V119	25	8									
	VVF53.25-10 <sup>4)</sup>	S55208-V120	25	8									
	VVF53.32-16 <sup>4)</sup>	S55208-V122	32	15									
	VVF53.40-12.5	S55208-V123	40	12.5									
	VVF53.40-16	S55208-V124	40	16									
	VVF53.40-20	S55208-V125	40	20									
VVF53.40-25 <sup>4)</sup>	S55208-V126	40	23										
VVF53.50-31.5	S55208-V127	50	31.5										
VVF53.50-40	S55208-V128	50	40										
VVF53.65-63	S55208-V129	65	63										
VVF53.80-100	S55208-V130	80	100										
VVF53.100-160 <sup>4)</sup>	S55208-V131	100	150										
VVF53.125-250 <sup>4)</sup>	S55208-V132	125	220										
VVF53.150-400 <sup>4)</sup>	S55208-V133	150	360										
					Δp <sub>max</sub> [kPa]								
													
	Stock no.	DN	k <sub>vs</sub> [m <sup>3</sup> /h]	S <sub>v</sub>	A→B	AB→A	A→B	AB→A	A→B	AB→A	A→B	AB→A	
<b>Fluids</b>	VXF53.15-1.6	S55208-V140	15	1.6		1200	200	1200	200	1200	200		
	VXF53.15-2.5	S55208-V141	15	2.5									
	VXF53.15-4	S55208-V142	15	4									
	VXF53.20-6.3	S55208-V144	20	6.3									
	VXF53.25-6.3	S55208-V145	25	6.3									
	VXF53.25-10	S55208-V146	25	10									
	VXF53.32-16	S55208-V148	32	16									
	VXF53.40-16	S55208-V149	40	16									
	VXF53.40-25	S55208-V150	40	25									
	VXF53.50-40	S55208-V152	50	40									
	VXF53.65-63	S55208-V153	65	63									
	VXF53.80-100	S55208-V154	80	100									
	VXF53.100-160	S55208-V155	100	160									
	VXF53.125-250	S55208-V156	125	250									
VXF53.150-400	S55208-V157	150	400										

- 1) DN 15...50: Flange dimensions for PN 16 and PN 25  
DN 65...150: Flange dimensions only for PN 25
- 2) Usable up to a max. medium temperature of 150 °C
- 3) Operate with opposite flow direction with steam
- 4) Reduced k<sub>vs</sub> value
- 5) Usable up to a max. medium temperature of 130 °C

**Note**



When using a stem heating element with a medium temperature of below  $-5\text{ }^{\circ}\text{C}$ , the stem sealing gland must be replaced. In this case, the sealing gland must be ordered separately.

DN	Stock number
DN 15...50	4 284 8806 0
DN 65...150	4 679 5629 0

Spare parts, Rev.-No.

See page 18

**Accessories**

Product number	Stock number	Description	Note	
ASZ6.6	S55845-Z108	Stem heating element	Required for medium temperatures $< 0\text{ }^{\circ}\text{C}$	
-	4 284 8806 0	Stem sealing gland	When using valves of the V..F53.. lines DN 15...50 with a stem heating element and a medium temperature below $-5\text{ }^{\circ}\text{C}$ , the stem sealing gland must be replaced. With the gland 428488060 the valve can be used with water, water with antifreeze and brines between $-20\text{ }^{\circ}\text{C}$ and $150\text{ }^{\circ}\text{C}$ .	
-	4 679 5629 0	Stem sealing gland	When using valves of the V..F53.. lines DN 65...150 with a stem heating element and a medium temperature below $-5\text{ }^{\circ}\text{C}$ , the stem sealing gland must be replaced. With the gland 467956290 the valve can be used with water, water with antifreeze and brines between $-20\text{ }^{\circ}\text{C}$ and $150\text{ }^{\circ}\text{C}$ .	

Adapter type	Stock number	Bolts included	Description	VXF41..	
ALF41B15	S55845-Z110	4x M12x90mm	Adapter for replacing 3-port valves VXF41.. by VXF53.. <ul style="list-style-type: none"> <li>• Due to different dimensions of the bypass flange</li> <li>• Every valve to be replaced requires an adapter</li> <li>• Adapter is supplied with the required number and size of bolts and nuts as well as two suitable flat sealings</li> </ul> Replace 3-port valves VXF41.., DN 65...150 by 3-port valves VXF43.. (data sheet N4404).	DN 15	
ALF41B25	S55845-Z111	4x M12x90mm		DN 25	
ALF41B40	S55845-Z112	4x M16x90mm		DN 40	
ALF41B50	S55845-Z113	4x M16x90mm		DN 50	

## Equipment combinations

Product number	Description	Stroke	Positioning force	Operating voltage	Positioning signal	Spring return time	Positioning time	LED	Manual adjuster	Auxiliary functions			
SAX31.00	S55150-A105	20 mm	800 N	AC 230 V	3-position	-	120 s	-	Push and fix	1), 2),			
SAX31.03	S55150-A106						30 s			3), 4)			
SAX61.03	S55150-A100			AC/DC 24 V	3-position		0...10 V 4...20 mA 0...1000 Ω			120 s	-	Push and fix	1), 2),
SAX81.00	S55150-A102									30 s			
SAX81.03	S55150-A103												
SAX81.03U	S55150-A103-A100												
SKD32.21	SKD32.21	20 mm	1000 N	AC 230 V	3-position	8 s	Opening: 30 s Closing: 10 s	-	Turn, Position is maintained	1), 2),			
SKD32.50	SKD32.50					-	120 s						
SKD32.51	SKD32.51					8 s							
SKD60	SKD60												
SKD62	SKD62			AC 24 V	3-position	0...10 V 4...20 mA 0...1000 Ω	15 s	Opening: 30 s Closing: 15 s	✓		3)		
SKD62U	SKD62U												
SKD62UA	SKD62UA												
SKD82.50	SKD82.50						3-position	8 s	120 s	-	-	-	1), 2),
SKD82.50U	SKD82.50U												
SKD82.51	SKD82.51												
SKD82.51U	SKD82.51U												
SKB32.50	SKB32.50	20 mm	2800 N	AC 230 V	3-position	-	120 s	-	Turn, Position is maintained	1), 2),			
SKB32.51	SKB32.51					10 s							
SKB60	SKB60												
SKB62	SKB62			AC 24 V	3-position	0...10 V 4...20 mA 0...1000 Ω	10 s	Opening: 120 s Closing: 10 s	✓		3)		
SKB62U	SKB62U												
SKB62UA	SKB62UA												
SKB82.50	SKB82.50						3-position	10 s	120 s	-	-	-	1), 2),
SKB82.50U	SKB82.50U												
SKB82.51	SKB82.51												
SKB82.51U	SKB82.51U												
SAV31.00	S55150-A112	40 mm	1600 N	AC 230 V	3-position	-	120 s	-	Push and fix	1), 2), 6)			
SAV61.00	S55150-A110			AC/DC 24 V	DC 0...10 V DC 4...24 mA 0...1000 Ω			3-position		✓	1), 3), 6), 7)		
SAV61.00U	S55150-A110-A100												
SAV81.00	S55150-A111									-	1), 2), 6)		
SAV81.00U	S55150-A111-A100												
SKC32.60	SKC32.60	40 mm	2800 N	AC 230 V	3-position	-	120 s	-	Turn, Position is maintained	1), 2),			
SKC32.61	SKC32.61					18 s							
SKC60	SKC60												
SKC62	SKC62			AC 24 V	3-position	0...10 V 4...20 mA 0...1000 Ω	20 s	Opening: 120 s Closing: 20 s	✓		3)		
SKC62U	SKC62U												
SKC62UA	SKC62UA												
SKC82.60	SKC82.60						3-position	18 s	120 s	-	-	-	1), 2),
SKC82.60U	SKC82.60U												
SKC82.61	SKC82.61												
SKC82.61U	SKC82.61U												

- 1) Auxiliary switch (optional)
- 2) Potentiometer (optional)
- 3) Position feedback, forced control, selection of valve characteristic
- 4) Optional: Sequence control, selection of acting direction
- 5) Plus sequence control, stroke limitation, and selection of acting direction
- 6) Stem heating element (optional)
- 7) Function module (optional)

## Ordering

---

### Example

Product number	Stock number	Description
VXF53.25-6.3	S55208-V145	3-port valve with flange, PN 25
SAX31.03	S55150-A106	Electro-hydraulic actuator

### Delivery

Valves, actuators and accessories are packed and delivered as separate items.

### Note

Counter-flanges, bolts and gaskets must be provided on site.





## Product documentation

---

• Mounting Instructions	M4030 74 319 0749 0	DN 15...150
	A6V10774961 A5W90000815	DN 200, DN 250
• Basic documentation	P4030	Contains background information and technical basic knowledge of valves





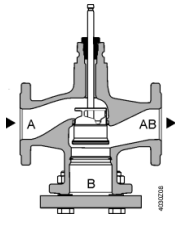
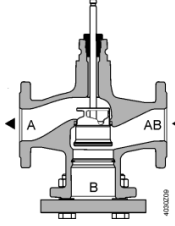

The illustrations below show the basic design of the valves. Constructional features, such as the shape of plugs, may differ.

**2-port valves**

 <b>Fluids</b>	 <b>Steam ( Fluids possible )</b>
 Closing against the pressure	 Closing with the pressure
 <p style="text-align: center;"><b>A → AB</b></p> <p style="text-align: center;">For use with all actuators</p>	 <p style="text-align: center;"><b>A ← AB</b></p> <p style="text-align: center;">Use with electro-hydraulic actuators only</p>

**2-port valves pressure compensated**

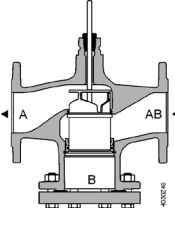
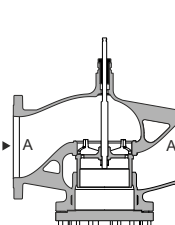

The VVF53..K valves use a pressure-compensated plug. This enables the same type of actuators to be used for the control of volumetric flow at higher differential pressures.

  <b>DN 65...150 Fluids and Steam</b>	  <b>DN 200, DN 250 Fluids and Steam</b>
 Closing with the pressure	 Closing against the pressure
 <p style="text-align: center;"><b>A ← AB</b></p> <p style="text-align: center;">Use with electro-hydraulic actuators only</p>	 <p style="text-align: center;"><b>A → AB</b></p> <p style="text-align: center;">Use with electro-hydraulic actuators only</p>

Note

**2-port valves do not become 3-port valves by removing the blank flange!**

**3-port valves**

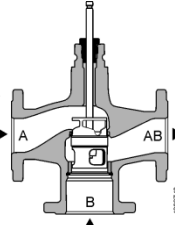
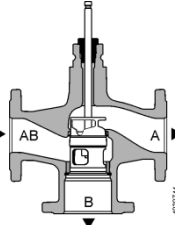
 <b>Fluids</b>	
 Mixing valve (preferred use)	 Diverting valve
 <p style="text-align: center;"><b>A T → AB</b> <b>B</b></p>	 <p style="text-align: center;"><b>AB T → A</b> <b>B</b></p>

Flow chart

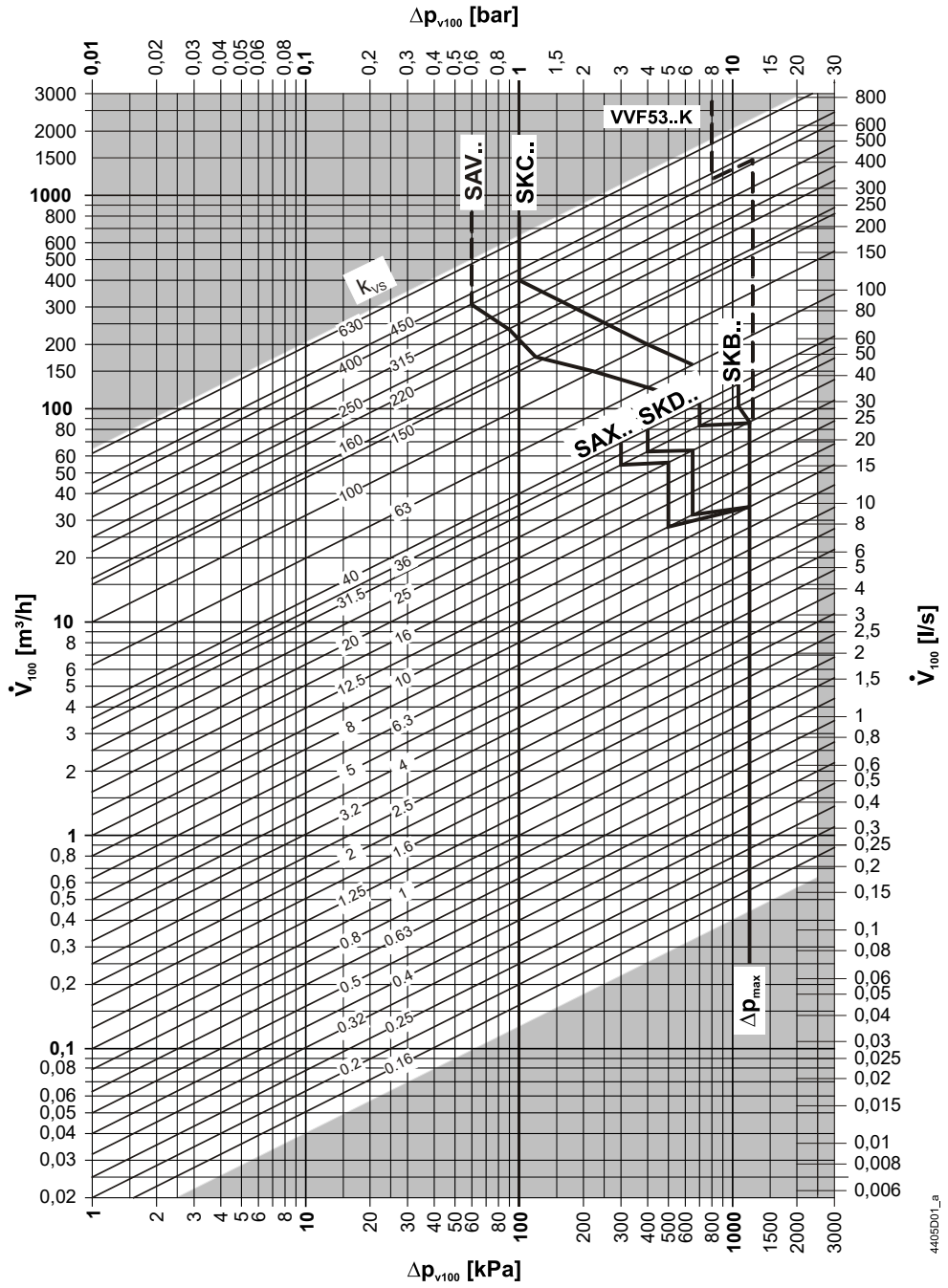

$\Delta p_{max}$  values apply for the mixing function.  $\Delta p_{max}$  values for the diverting function see table "Type summary", page 2

$\Delta p_{max}$  values for  $k_{vs}$  value 16, DN 32, see table "Type summary", page 2

4405D01\_L8



**Valve characteristics**  
**2-port valves**

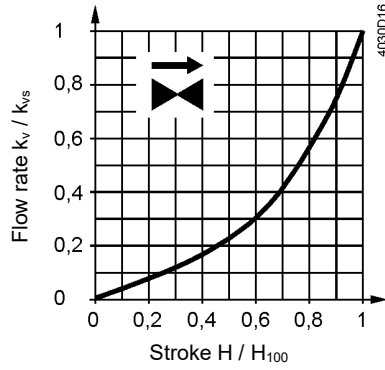

0...30 %: Linear  
30...100 %: Equal percentage  
 $n_{gl} = 3$  to VDI / VDE 2173

For high  $k_{vs}$  values the valve characteristic is optimized for maximum volumetric flow  $k_{V100}$ .

For product lines:

- VVF53.125-200
- VVF53.125-250
- VVF53.125-220K
- VVF53.150-315
- VVF53.150-400
- VVF53.150-315K
- VVF53.200-450K
- VVF53.250-630K

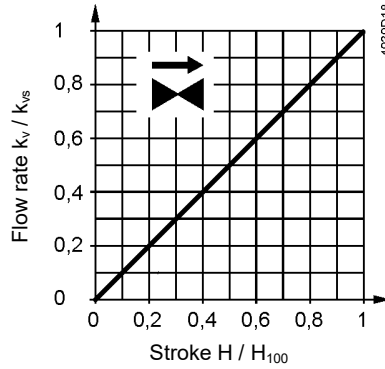

0...100 %: Linear

**3-port valves**

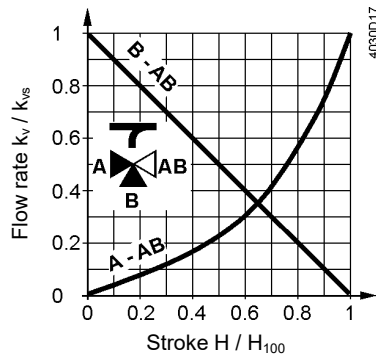

**Throughport A-AB**

0...30 %: Linear  
30...100 %: Equal percentage  
 $n_{gl} = 3$  to VDI / VDE 2173

For high  $k_{vs}$  values the valve characteristic is optimized for maximum volumetric flow  $k_{V100}$ .

**Bypass B-AB**

0...100 %: Linear

Port AB = constant volumetric flow

Port A = variable volumetric flow

Port B = Bypass (variable volumetric flow)

**Mixing:**

Volumetric flow from port A and port B to port AB

**Diverting:**

Volumetric flow from port AB to port A and port B

For product lines:

- VXF53.125-250
- VXF53.150-400

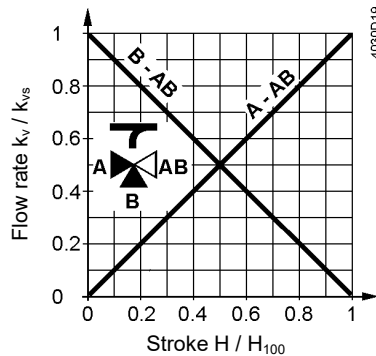

**Throughport A-AB**

0...100 %: Linear

**Bypass B-AB**

0...100 %: Linear

### Operating pressure and medium temperature

Fluids with V..F53..

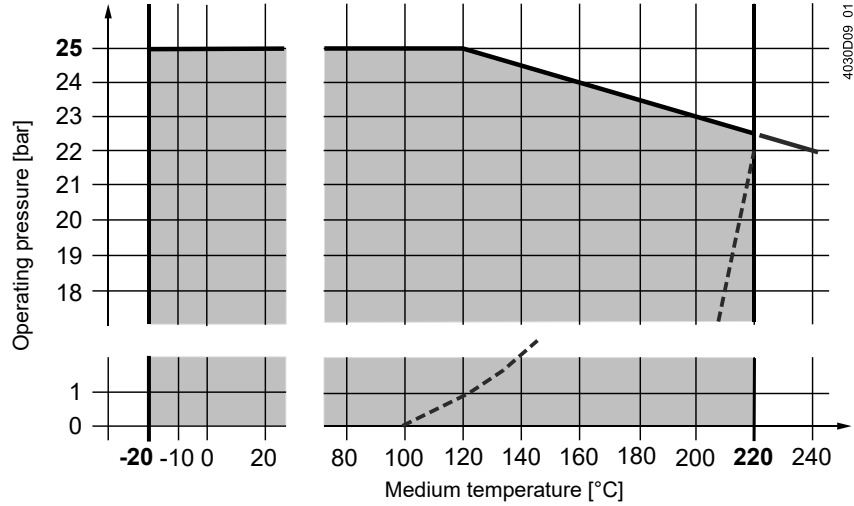

--- Curve for saturated steam; steam forms below this line

— · · Operating pressure according to EN 1092, valid for 2-port valves with blank flange

### Operating pressure and operating temperatures according to ISO 7005, EN 1092 and EN 12284

Notes

All relevant local directives must be observed

Saturated steam  
Superheated steam  
with VVF53..

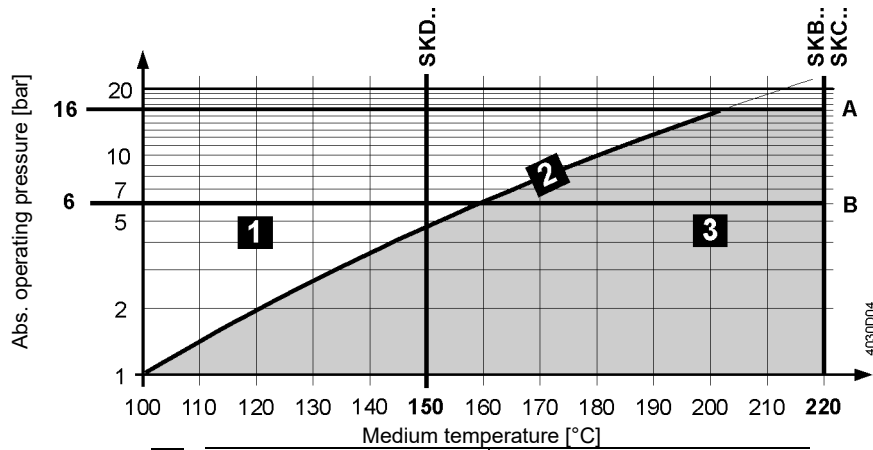

<b>1</b>	Water	-
<b>2</b>	Wet steam	To be avoided
<b>3</b>	Saturated steam Superheated steam	Permissible operating range
A	Subcritical pressure ratio	
B	Supercritical pressure ratio	

## Medium compatibility and temperature ranges

Medium	Temperature range		Valve			Note
	T <sub>min</sub> [°C]	T <sub>max</sub> [°C]	VVF53..	VVF53..K	VXF53..	
Cold water	1	25	■	■	■	-
Low-temperature hot water	1	130	■	■	■	-
High-temperature hot water <sup>1)</sup>	130	150	■	■	■	-
	150	180	■	■	■	-
	180	220	■	■	■	-
Water with antifreeze	-5	150	■	■	■	V..F53: With a medium temperature of below -5 °C, the stem sealing gland must be replaced by DN 15...50: 428488060 DN 65...150: 467956290
	-10	150	■	- <sup>3)</sup>	■	
	-20	150	■	- <sup>3)</sup>	■	
Cooling water <sup>2)</sup>	1	25	■	■	■	-
Brines	-5	150	■	■	■	V..F53: With a medium temperature of below -5 °C, the stem sealing gland must be replaced by DN 15...50: 428488060 DN 65...150: 467956290
	-10	150	■	- <sup>3)</sup>	■	
	-20	150	■	- <sup>3)</sup>	■	
Saturated steam	100	150	■	■	-	-
	100	220	■	■	-	-
Superheated steam	120	150	■	■	-	-
	120	220	■	■	-	-
Heat transfer oils	20	220	■	■	■	On the basis of mineral oil
Super-clean water (demineralized and deionized)	1	150	-	-	-	

<sup>1)</sup> Differentiation due to saturated steam curve

<sup>2)</sup> Open circuits

<sup>3)</sup> VVF53..K can't be used with media below -5 °C due to the compensation sealing material

## Fields of use

Fields of use		Valve	
		VVF53..	VXF53..
<b>Generation</b>	Boiler plants	■	■
	District heating plants	■	-
	Refrigeration plants	■	■
	Cooling towers <sup>1)</sup>	■	■
<b>Distribution</b>	Heating groups	■	■
	Air handling units	■	■

<sup>1)</sup> Open circuits

## Engineering notes

Mounting location	Preferably mount the valves at the return, as the temperature is lower there and the strain on the stem sealing gland is lower.
Dirt trap	Mount a dirt filter or dirt trap before the valve to ensure proper functioning, and a long service life of the valve. Remove dirt, welding beads, etc. from the valves and pipes.
Cavitation	Cavitation can be avoided by limiting the pressure differential across the valve depending on the medium temperature and the prepressure.

## Mounting notes

Mounting position

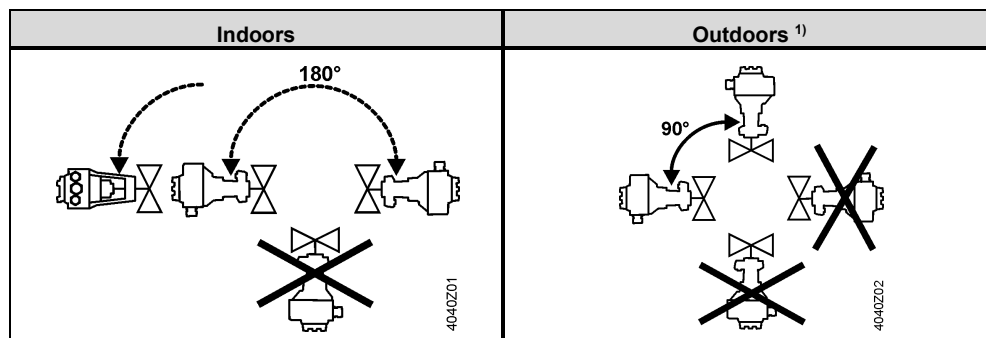

<sup>1)</sup> Only in combination with weather shield ASK39.1 and actuators SAX..

Mounting positions apply to both 2- and 3-port valves.

## Commissioning notes



**The valve may be put into operation only if actuator and valve are correctly assembled.**

Note

Ensure that actuator stem and valve stem are rigidly connected in all positions.

Function check

Valve	Throughport A→AB or AB→A	Bypass B→AB
Valve stem extends	Closes	Opens
Valve stem retracts	Opens	Closes

## Maintenance notes

The valves are maintenance-free.



When servicing valves or actuators:

- Deactivate the pump and turn off the power supply
- Close the shutoff valves
- Fully reduce the pressure in the piping system and allow pipes to completely cool down

If necessary, disconnect the electrical wires.

Disposal

Do not dispose of the device as unsorted municipal waste.

- Special handling of individual components may be mandated by law or make ecological sense.
- Observe all local and currently applicable laws and regulations.

## Warranty

Application-related technical data are guaranteed only when the valves are used in connection with the Siemens actuators listed under "Equipment combinations", page 3.

When used with actuators of other manufacture, any warranty by Siemens becomes void.

## Technical Data

Functional data	PN class	PN 25
	Connection	Flange
	Operating pressure	See Section "Operating pressure and medium temperature" page 10
	Valve characteristics <sup>1)</sup>	See section "Valve characteristics", page 9
	Leakage rate Throughport	DN 15...150: 0...0.01 % of $k_{vs}$ value (Class IV) DN 200, DN 250: 0...0.02 % of $k_{vs}$ value
	Bypass Bypass	0.5...2 % of $k_{vs}$ value with SKD..., SKB..., SKC.. 0...0.05 % of $k_{vs}$ value with SAX..., SAV..
	Permissible media	See table "Medium compatibility and temperature ranges", page 11
	Medium temperature	-20...220 °C <sup>2)</sup> VVF53..K: -5...220 °C
	Rangeability	DN 15, $k_{vs} \leq 1.25 \text{ m}^3/\text{h}$ : >50 DN 15...150: >100 DN 200, DN 250: >50
	Nominal stroke	Up to DN 50: 20 mm From DN 65: 40 mm
	Materials	Valve body
Blank flange VVF..		DN 15...250: P265GH (EN 10028-2)
Valve stem, seat, plug		Stainless steel
Stem sealing gland		Stainless steel DN 15...150: FEPM (silicone-free) DN 200, DN 250: PTFE (not silicone-free)
Compensation sealing		Stainless steel DN 50...150: FEPM (silicone-free) DN 200, DN 250: PTFE+carbon (not silicone-free)
Adapter ALF41B..		Steel S235JRG2
Norms and directives	Pressure Equipment Directive	PED 2014/68/EU
	Pressure Accessories	Scope: Article 1, section 1 Definition: Article 2, section 5
	Fluid group 2:	
	≤ DN 40	without CE-marking, as per article 4, section 3 (sound engineering practice) <sup>3)</sup>
	DN 50...100	Category I, Module A, with CE-marking, as per article 14, section 2
	DN 125...150	Category II, Module A2, with CE-marking, as per article 14, section 2 notified body number 0036
	DN 200, DN 250	Category II, Module A2, with CE-marking, as per article 14, section 2 notified body number 0035
	EU Conformity (CE)	
	DN 50...150	A5W00006523 <sup>4)</sup>
	DN 200, DN 250	A5W90001026 <sup>4)</sup>
PN class	ISO 7268	
Operating pressure	ISO 7005, DIN EN 12284	
Flanges	ISO 7005	
Length of flanged valves	DIN EN 558-1, line 1	
Valve characteristic	VDI 2173	

	Leakage rate	Throughport, Bypass according to EN 60534-4 / EN 1349	
	Water treatment	VDI 2035	
Environmental conditions	Storage: IEC 60721-3-1	Class	1K3
		Temperature	-15...55 °C
		Rel. humidity	5...95 % r.h.
	Transport: IEC 60721-3-2	Class	2K3, 2M2
		Temperature	-30...65 °C
		Rel. humidity	< 95 % r.H.
	Operation: IEC 60721-3-3	Class	3K5, 3Z11
Temperature		-15...55 °C	
Rel. humidity		5...95 % r.h.	
Environmental compatibility	The product environmental declaration CE1E4405en01 <sup>4)</sup> , CE1E4405en02 <sup>4)</sup> , CE1E4404en02 <sup>4)</sup> and A5W90001031 <sup>4)</sup> contains data on environmentally compatible product design and assessments (RoHS compliance, materials composition, packaging, environmental benefit, disposal).		
Dimensions / Weight	Dimensions	See „Dimensions“, page 15 + 16	
	Weight	See „Dimensions“, page 15 + 16	

- <sup>1)</sup> For certain valve lines and high  $k_{vs}$  values, the valve characteristic is optimized for maximum volumetric flow  $k_{V100}$
- <sup>2)</sup> With SAX.. and SAV...: Usable up to a max. medium temperature of 130 °C  
With SKD...: Usable up to a max. medium temperature of 150 °C  
For medium temperatures < -5 °C, the stem sealing gland must be replaced, please see page 4.
- <sup>3)</sup> Valves where  $PS \times DN < 1000$ , do not require special testing and cannot carry the CE label.
- <sup>4)</sup> The documents can be downloaded from <http://www.siemens.com/bt/download>

## Dimensions

### VVF53..

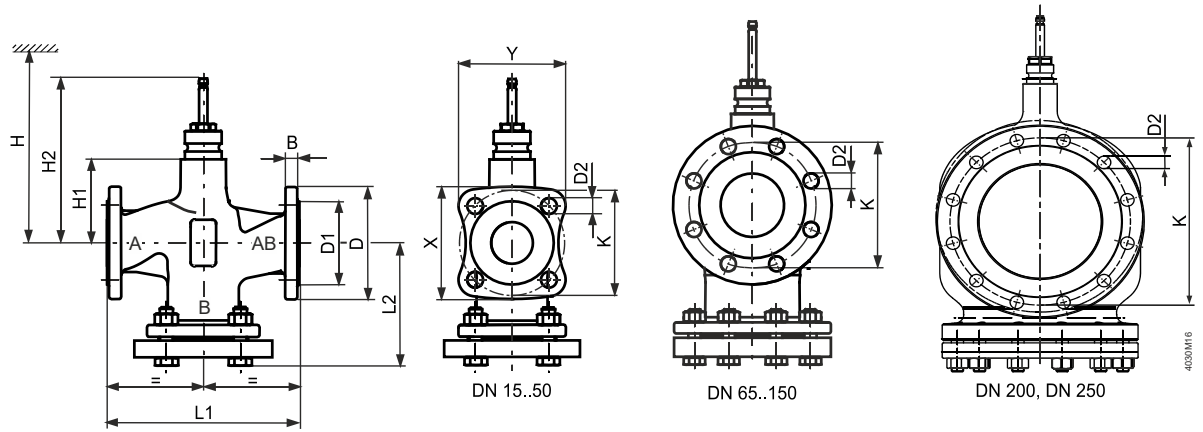

Product number	DN	kg	B	Ø D	Ø D1	Ø D2	L1	L2	X	Y	Ø K	H1	H2	H				
														SAX..	SKD..	SKB..	SAV..	SKC..
VVF53..	15	4.2	14	95	46	14 (4x)	130	87.5	79	76	65	63	159.5	505	563	638	-	-
	20	5.3	16	105	56	14 (4x)	150	99.5	86.6	83	75	63	144.4	505	563	638	-	-
	25	6.1	15	115	65	14 (4x)	160	104.5	94.4	90.1	85	63	159.5	505	563	638	-	-
	32	8.7	17	140	76	19 (4x)	180	119	115.6	110.7	100	60	156.5	502	560	635	-	-
	40	10.1	16	150	84	19 (4x)	200	129	123.2	117.8	110	60	156.5	502	560	635	525	-
	50	13.6	16	165	99	19 (4x)	230	146	135.2	128.4	125	100	196.5	542	600	675	565	-
	65	22	17	185	118	19 (8x)	290	178	-	-	145	115	231.5	-	-	-	580	690
	80	27.4	17	200	132	19 (8x)	310	190	-	-	160	115	231.5	-	-	-	580	690
	100	38.2	17	235	156	23 (8x)	350	212.5	-	-	190	146	262.5	-	-	-	611	721
	125	53.1	17	270	184	28 (8x)	400	242	-	-	220	159	275.5	-	-	-	624	734
VVF53..K	150	73.4	17	297	211	28 (8x)	480	284	-	-	250	186.5	303	-	-	-	652	762
	50	13.6	16	165	99	19 (4x)	230	146	135.2	128.4	125	100	196.5	-	600	675	-	-
	65	22	17	185	118	19 (8x)	290	178	-	-	145	115	231.5	-	-	-	-	690
	80	27.6	17	200	132	19 (8x)	310	190	-	-	160	115	231.5	-	-	-	-	690
	100	38.6	17	235	156	23 (8x)	350	212.5	-	-	190	146	262.5	-	-	-	-	721
	125	53.8	17	270	184	28 (8x)	400	242	-	-	220	159	275.5	-	-	-	-	734
	150	75	17	297	211	28 (8x)	480	284	-	-	250	186.5	303	-	-	-	-	762
	200	133	30	360	274	26 (12X)	600	265	-	-	310	243	359.5	-	-	-	-	818
	250	200	32	425	330	30 (12X)	730	290	-	-	370	275	391.5	-	-	-	-	850

VXF53..

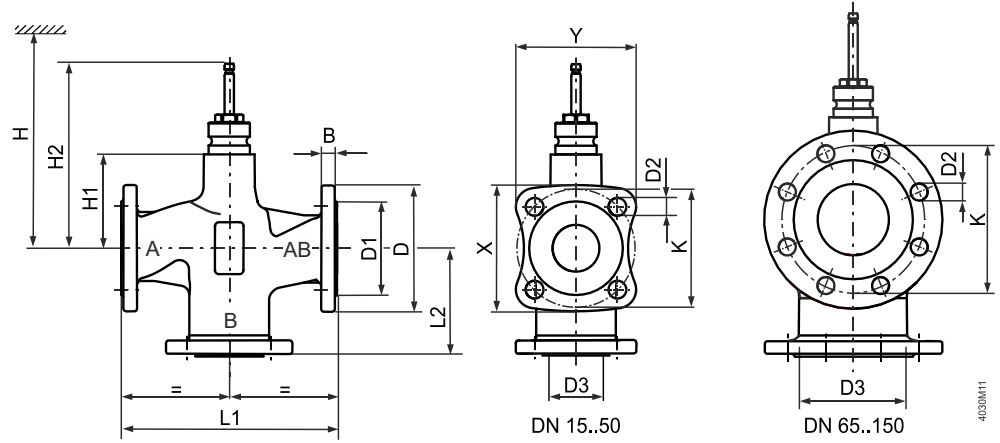





Product number	DN	K <sub>vs</sub>	B	Ø D	Ø D1	Ø D2	Ø D3 <sup>1)</sup>	L1	L2	X	Y	Ø K	H1	H2	H				
															SAX..	SKD..	SKB..	SAV..	SKC..
VXF53..	15	3.2	14	95	46	14 (4x)	25	130	65	79	76	65	63	159.5	505	563	638	-	-
	20	4.0	16	105	56	14 (4x)	35	150	75	86.6	83	75	63	159.5	505	563	638	-	-
	25	4.6	15	115	65	14 (4x)	38	160	80	94.4	90.1	85	63	159.5	505	563	638	-	-
	32	6.1	17	140	76	19 (4x)	46	180	90	115.6	110.7	100	60	156.5	502	560	635	-	-
	40	7.2	16	150	84	19 (4x)	57	200	100	123.2	117.8	110	60	156.5	502	560	635	525	-
	50	9.7	16	165	99	19 (4x)	69	230	115	135.2	128.4	125	100	196.5	542	600	675	565	-
	65	16.3	17	185	118	19 (8x)	86	290	145	-	-	145	115	231.5	-	-	-	580	690
	80	20.6	17	200	132	19 (8x)	100	310	155	-	-	160	115	231.5	-	-	-	580	690
	100	28.1	17	235	156	23 (8x)	123	350	175	-	-	190	146	262.5	-	-	-	611	721
	125	38.5	17	270	184	28 (8x)	149	400	200	-	-	220	159	275.5	-	-	-	624	734
150	54.9	17	297	211	28 (8x)	174	480	240	-	-	250	186.5	303	-	-	-	652	762	

<sup>1)</sup> Interior opening of the bypass port



## Spare parts

### Stem sealing gland

Product number	DN	Stock number	Comments	
VVF53.. VXF53.. VVF53..K	DN 15...50 and DN 65...150 Series A, B and C	74 284 0061 0	Standard version with FEPM-O-ring for medium temperatures between -5 °C and 220 °C.	
VVF53.. VXF53.. VVF53..K	DN 65...150 As from series D	S55846-Z114	Standard version with FEPM-O-ring for medium temperatures between -5 °C and 220 °C.	
VVF53.. K	DN 200, DN 250	4 679 5630 0	Standard version with PTFE sleeve for medium temperatures between -5 °C and 220 °C	
VVF53.. VXF53..	DN 15...50	4 284 8806 0	When operating with medium temperatures below -5 °C. With the gland 428488060 the valve can be used with water, water with antifreeze and brines between -20 °C and 150 °C.	
VVF53.. VXF53..	DN 65...150	4 679 5629 0	When operating with medium temperatures below -5 °C. With the gland 467956290 the valve can be used with water, water with antifreeze and brines between -20 °C and 150 °C.	
VVF53..	DN 65...150	4 679 5629 0	When operating with medium temperatures below -5 °C. With the gland 467956290 the valve can be used with water, water with antifreeze and brines between -20 °C and 150 °C.	
VXF53..	DN 15...50	4 284 8806 0	When operating with medium temperatures below -5 °C. With the gland 467956290 the valve can be used with water, water with antifreeze and brines between -20 °C and 150 °C..	
VVF53.. VVF53..K	DN 15...150 and DN65... 150 series A, B and C	74 284 0061 0	Standard version with FEPM-O-ring for medium temperatures between -5 °C and 220 °C.	
VVF53.. VVF53..K	DN 65...150 As from series D	S55846-Z114	Standard version with FEPM-O-ring for medium temperatures between -5 °C and 220 °C.	
VVF53..K	DN 200, DN 250	4 679 5630 0	Standard version with FEPM-O-ring for medium temperatures between -5 °C and 220 °C.	

## Revision numbers

Product number	Valid from rev. no.	Product number	Valid from rev. no.	Product number	Valid from rev. no.
VVF53.15-0.16	..A	VVF53.50-40K	..D	VXF53.15-1.6	..A
VVF53.15-0.2	..A	VVF53.65-63K	..D	VXF53.15-2.5	..A
VVF53.15-0.25	..A	VVF53.80-100K	..D	VXF53.15-4	..A
VVF53.15-0.32	..A	VVF53.100-150K	..D	VXF53.20-6.3	..A
VVF53.15-0.4	..A	VVF53.125-220K	..D	VXF53.25-6.3	..A
VVF53.15-0.5	..A	VVF53.150-315K	..D	VXF53.25-10	..A
VVF53.15-0.63	..A	VVF53.200-450K	..A	VXF53.32-16	..A
VVF53.15-0.8	..A	VVF53.250-630K	..A	VXF53.40-16	..A
VVF53.15-1	..A			VXF53.40-25	..A
VVF53.15-1.25	..A			VXF53.50-40	..B
VVF53.15-1.6	..A			VXF53.65-63	..D
VVF53.15-2	..A			VXF53.80-100	..D
VVF53.15-2.5	..A			VXF53.100-160	..D
VVF53.15-3.2	..A			VXF53.125-250	..D
VVF53.15-4	..A			VXF53.150-400	..D
VVF53.20-6.3	..A				
VVF53.25-5	..A				
VVF53.25-6.3	..A				
VVF53.25-8	..A				
VVF53.25-10	..A				
VVF53.32-16	..A				
VVF53.40-12.5	..A				
VVF53.40-16	..A				
VVF53.40-20	..A				
VVF53.40-25	..A				
VVF53.50-31.5	..B				
VVF53.50-40	..B				
VVF53.65-63	..D				
VVF53.80-100	..D				
VVF53.100-160	..D				
VVF53.125-250	..D				
VVF53.150-400	..D				

Issued by  
Siemens Switzerland Ltd  
Smart Infrastructure  
Global Headquarters  
Theilerstrasse 1a  
6300 Zug  
Switzerland  
Tel. +41 58-724 24 24  
[www.siemens.com/buildingtechnologies](http://www.siemens.com/buildingtechnologies)

© Siemens Switzerland Ltd, 2011  
Technical specifications and availability subject to change without notice.